

8 | 7 | 6 | 5 | 4 | 3 | 2 | 1

D

C

B

A

C

C

B

A

P904 DMX Input

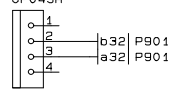

P905 Analog Input

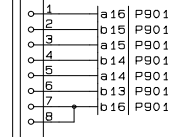

P906 Analog Input

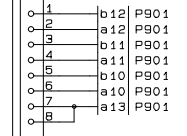

P907 External Micro-Wire port

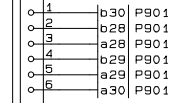

Diagnostics Port

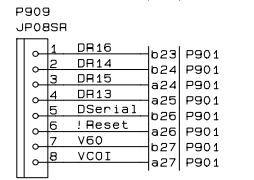
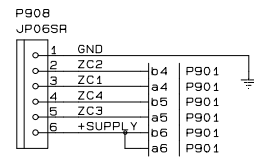

Please label connector area on silkscreen. Please add pin 1 to ground on P908.

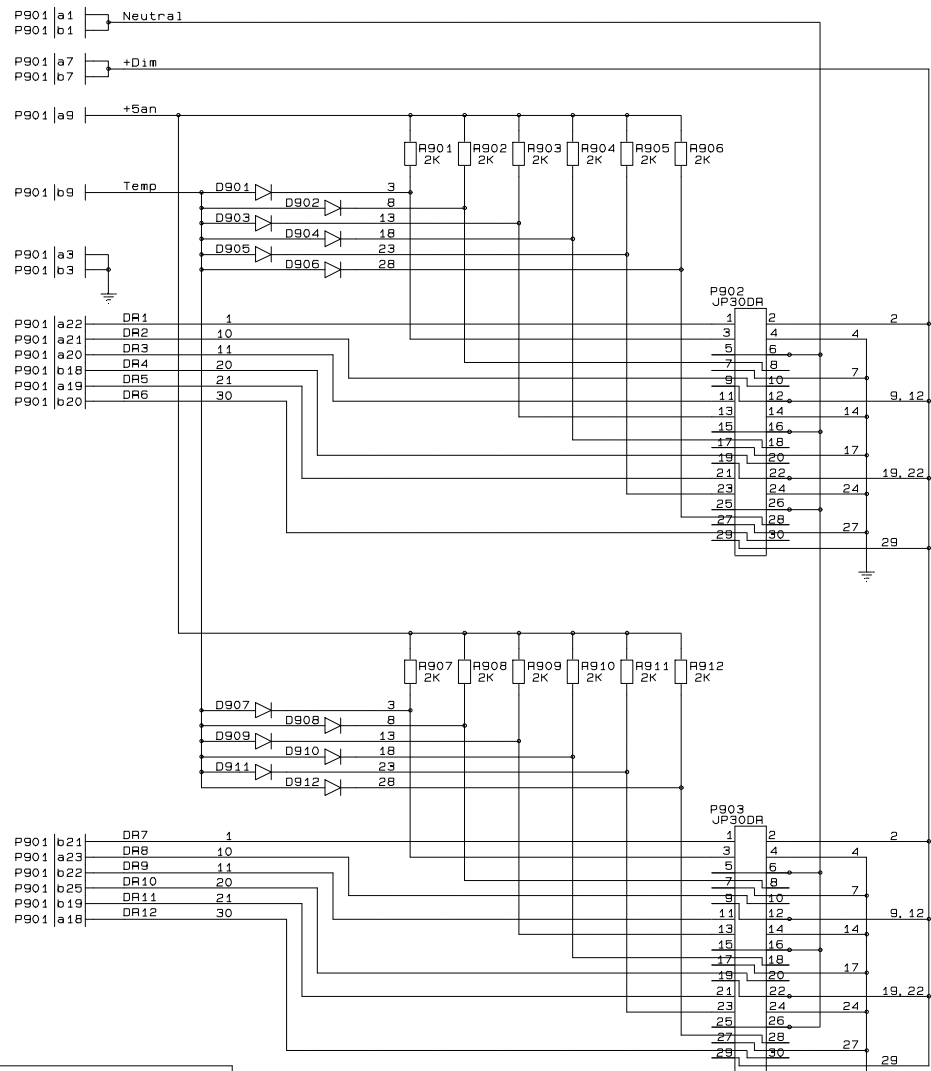

C:\SCHEMA\DWG\VX2400\30-1108B.P01

10087 Industrial Drive
Hamburg, MI 48139 USA
CAE, Inc. (313) 231-9373

VX2400 Control Breakout

D	PCB 30-1108B	Rev. B
DATE: 17 Feb 94 DDC	SHEET 01 OF 01	

8 | 7 | 6 | 5 | 4 | 3 | 2 | 1