

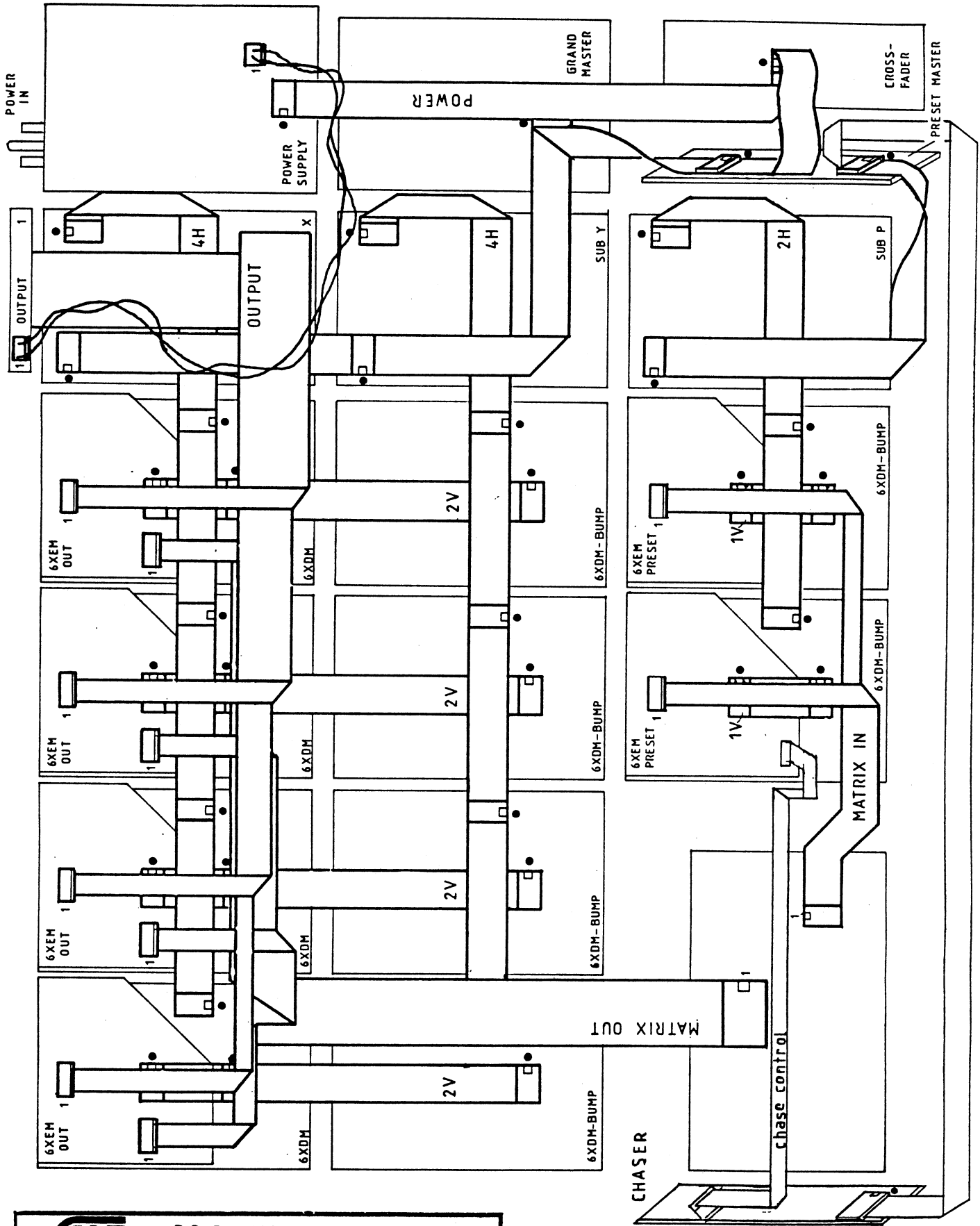

FRONT VIEW

PINS 1-24 — CHANNELS 1-24
 PIN 25 — V+
 PINS 26-27 — COMMON

| | | | |
|--|-------------|---|------------------------------|
|  | | P.O. Box 430 • 10087 Industrial Drive Hamburg, MI 48139 • 313/231-9373 | |
| TITLE OUTPUT CONNECTOR PIN ASSIGN | | | |
| SCALE | | TOLERANCE | PROJECT LEPER |
| DATE | 6/81 | | |
| DRAWN BY | JEF | MATERIAL | DRAWING NUMBER 10A |
| APP BY | | | |



| | | | |
|---|--------------|---|--|
|  | | P.O. Box 430 • 10087 Industrial Drive Hamburg, MI 48139 • 313/231-9373 | |
| SCALE: | APPROVED BY: | DRAWN BY <i>GEF</i> | |
| DATE 4/8/81 | | REVISED | |
| LEPRECON WIRING DIAGRAM | | | |
| 10B | | DRAWING NUMBER | |

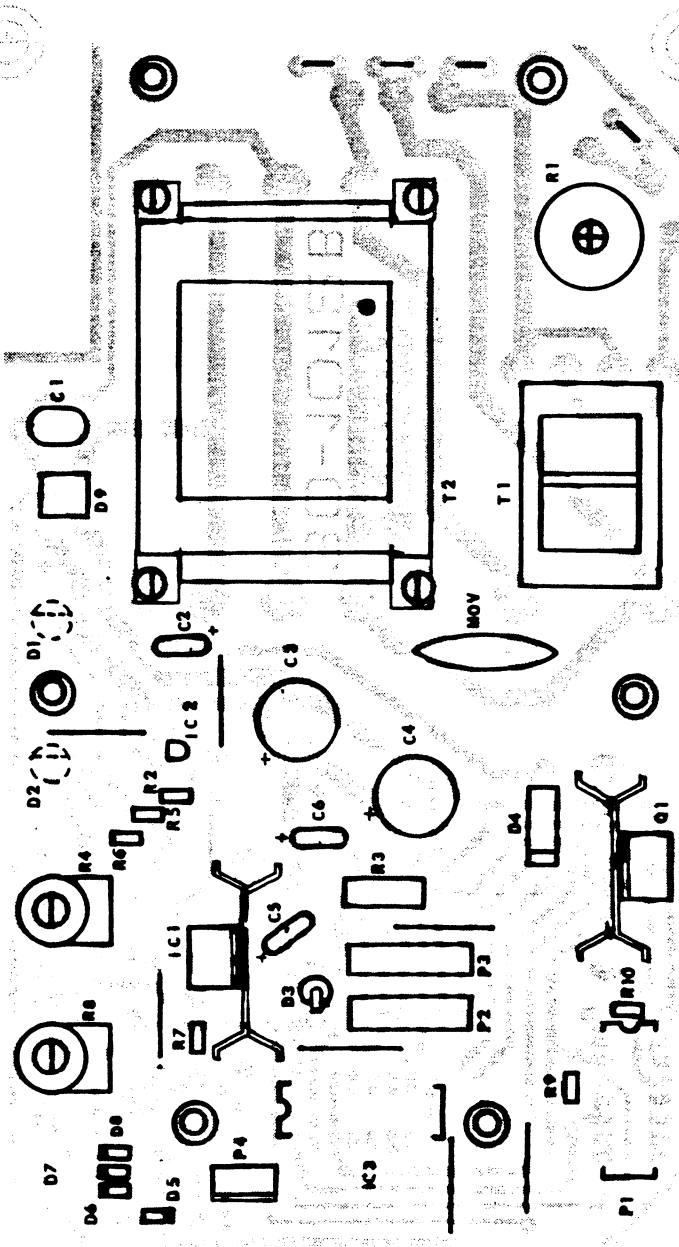

PARTS SIDE VIEW

PARTS LIST 30-1012B

| CONNECTORS | PART NUMBER | DESCRIPTION |
|----------------------------|-------------|-------------------------------|
| P1 | 07-0011 | 16 pin dip |
| P2 | 07-0022 | 6 pin header |
| P3 | 07-0022 | 6 pin header |
| P4 | 07-0028 | 2 pin header |
| P5 | 50-02-0001 | Prep. inlet, power supply |
| SWITCHES | | |
| SW1 | 09-0023 | Switch, rocker, illuminated |
| MISCELLANEOUS | | |
| MOV | 15-9005 | M.O.V. |
| TRANSFORMERS | | |
| T1 | 10-0015 | Transformer, PC 40-600 |
| T2 | 10-0016 | Transformer, ST 3-24 |
| INTEGRATED CIRCUITS | | |
| IC1 | 06-0038 | IC, LM340T-24 |
| IC2 | 06-0056 | IC, LM317L2 |
| IC3 | 06-0001 | IC, LM324M |
| TRANSISTOR | | |
| Q1 | 04-0013 | Transistor, 2N6109 |
| DIODES | | |
| D1 | 03-1001 | Diode, Green LED .2" dia. |
| D2 | 03-1001 | Diode, Green LED .2" dia. |
| D3 | 03-0003 | Diode, 3A 200V |
| D4 | 03-0003 | Diode, 3A 200V |
| D5 | 03-2001 | Diode, 4.7V 1/2W Zener |
| D6 | 03-0002 | Diode, 1N 4002 |
| D7 | 03-0002 | |
| D8 | 03-0002 | |
| D9 | 03-0013 | Diode, 1amp 200V Bridge |
| CAPACITORS | | |
| C1 | 02-1001 | Cap, .1uf 250V radial |
| C2 | 02-2026 | Cap, 1uf 35V tant radial |
| C3 | 02-2040 | Cap, 1000uf 50V radial elec. |
| C4 | 02-2040 | |
| C5 | 02-2026 | Cap, 1uf 35V tant. radial |
| C6 | 02-2026 | |
| RESISTORS | | |
| R1 | 24-2010 | Pot, w/bushing and nut |
| R2 | 01-0080 | Res, 2K .25 watt |
| R3 | 01-9001 | Res, 470 ohm 3 watt |
| R4 | 08-1029 | Pot, 10K linear 5/8" trim |
| R5 | 01-0073 | Res, 1K .25 watt |
| R6 | 01-0080 | Res, 2K .25 watt |
| R7 | 01-0080 | |
| R8 | 08-1029 | Pot, 10K linear 5/8" trim |
| R9 | 01-0080 | Res, 2K .25 watt |
| R10 | 01-0070 | Res, 750 .25 watt |
| CIRCUIT BREAKER | | |
| C.B. | 15-4023 | Circuit breaker, .65A thermal |

| | | | |
|--|--------------|---|-------------------------|
|  | | P.O. Box 430 • 10087 Industrial Drive Hamburg, MI 48139 • 313/231-9373 | |
| SCALE: | APPROVED BY: | DRAWN BY: | |
| DATE: | | REVISED: | |
| LEPRECON POWER SUPPLY PARTS | | | |
| PCB 30-1012 | | | DRAWING NUMBER P 11B |

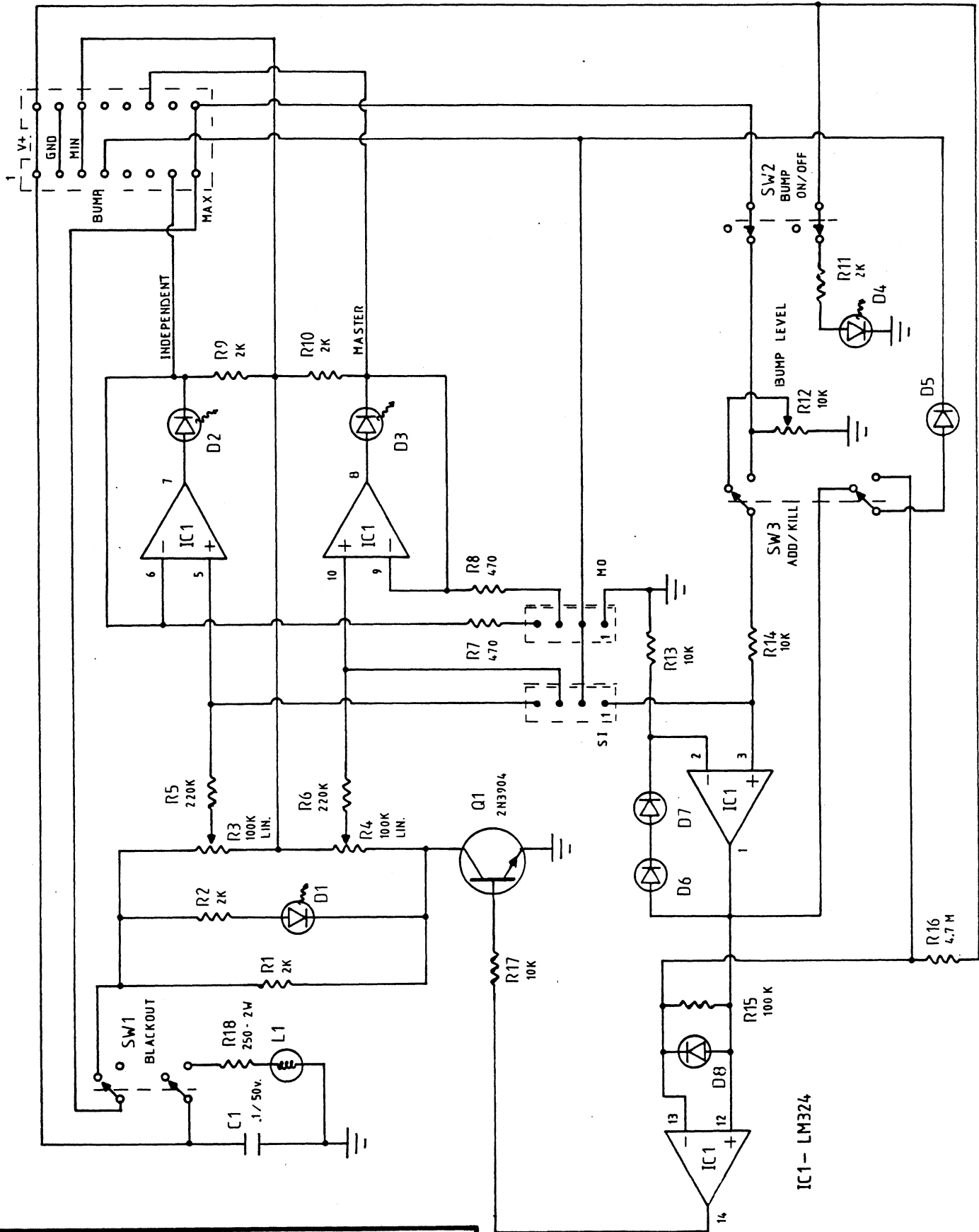

IC1 - LM324

| | | | |
|--|--------------|---|-----|
|  | | P.O. Box 430 • 10087 Industrial Drive Hamburg, MI 48139 • 313/231-9373 | |
| SCALE: | APPROVED BY: | DRAWN BY: | JJE |
| DATE: 2/11/81 | | REVISED: | |
| GRANDMASTER SCHEMATIC | | | |
| PCB 30-1016 | | DRAWING NUMBER Pc 12A | |

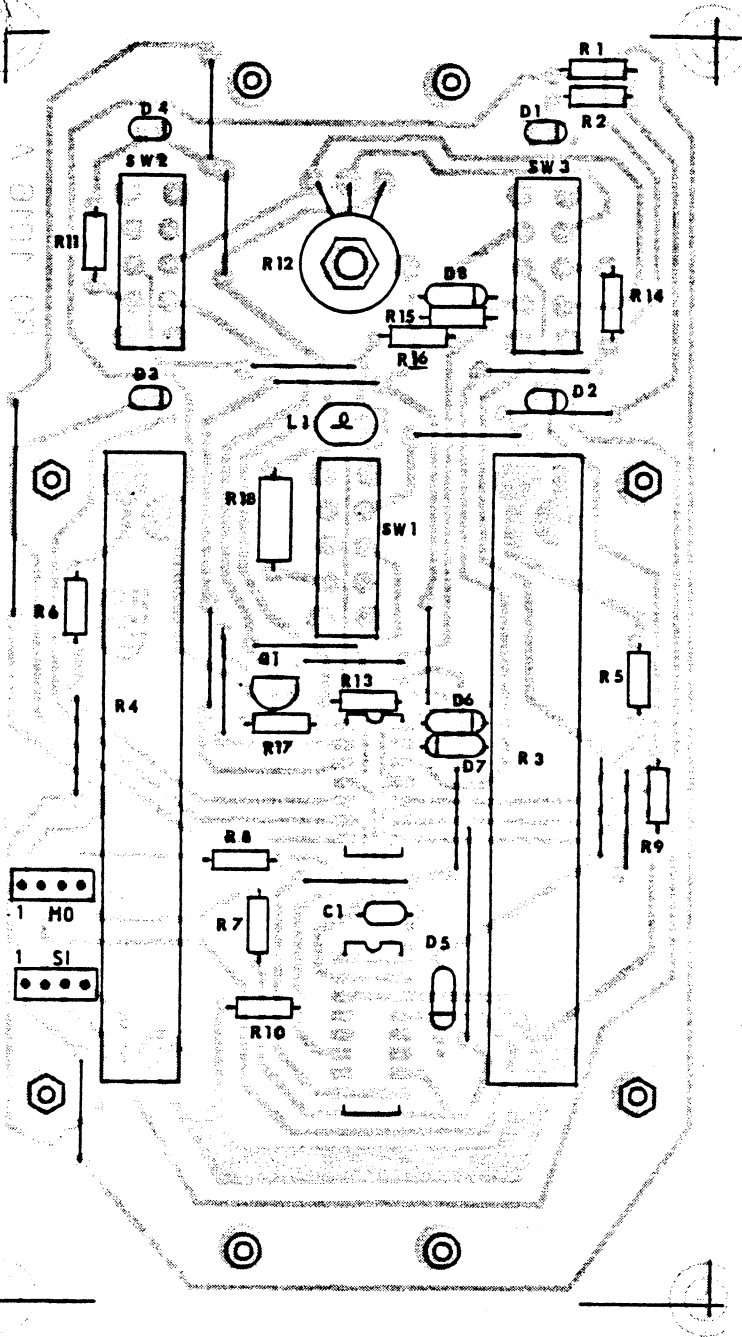

PARTS SIDE VIEW

30-1016 A

PARTS LIST 30-1016

| RESISTORS | PART NUMBER | DESCRIPTION |
|----------------------------|-------------|---------------------------------------|
| R1-R2 | 01-0080 | 2k |
| R3-R4 | 08-0001 | 100k Lin. Slide Pot |
| R5-R6 | 01-0129 | 220k |
| R7-R8 | 01-0065 | 470 |
| R9-R11 | 01-0080 | 2k |
| R12 | 08-1030 | 10k Lin Pot |
| R13-R14 | 01-0097 | 10k |
| R15 | 01-0121 | 100k |
| R16 | 01-0161 | 4.7M |
| R17 | 01-0097 | 10k |
| R18 | 01-9014 | 250, 2W |
| CAPACITORS | | |
| C1 | 02-0008 | .1/50V. Disc. |
| DIODES | | |
| D1 | 03-1002 | Yel. LED |
| D2-D3 | 03-1001 | Grn. LED |
| D4 | 03-1002 | Yel. LED |
| D5-D8 | 03-0002 | IN4002 |
| INTEGRATED CIRCUITS | | |
| IC1 | 06-0001 | LM 324 |
| TRANSISTORS | | |
| Q1 | 04-0011 | 2N3904 |
| SWITCHES | | |
| SW1 | 09-0025 | C & K Rocker |
| SW2-SW3 | 09-0028 | C & K Mini-Rocker |
| LAMP | | |
| | 15-5004 | 5V. Grain-o-wheat (mounted on switch) |

| | | | |
|--|--------------|---|--|
|  | | P.O. Box 430 • 10087 Industrial Drive Hamburg, MI 48139 • 313/231-9373 | |
| SCALE: | APPROVED BY: | DRAWN BY JGF | |
| DATE March 24, 1988 | | REVISED | |
| GRANDMASTER PARTS | | | |
| PCB 30-1016 | | DRAWING NUMBER P ₅ 128 | |